

HAND10 AREA LIGHT

Introduction

- ◆ The Hand 10 the is latest generation Area Light of XSY Lighting, it is highly cost effective, offers complete configurations. The Hand 10 delivers 11000lm to 48000lm lumens, which can replace 250W to 1000W HID luminaires.
- ◆ The whole family includes three different size, Slipfitter mount, square or round pole mount arm and Yoke mount are available.
- ◆ Photocell, motion sensor and external light control shield are also available.

Features

Construction

- ◆ The Hand 10 area light features a rugged die-cast aluminum body that uses heatsink and flow-through venting to provide optimal thermal management that both enhances LED performance and extends component life. The light housing is sealed against moisture and environmental contaminants. 3G vibration rated compact design minimizes wind load requirements. Low EPA, allowing pole optimization.

Electrical:

- ◆ Universal 120-277VAC, 120-347VAC or 277-480VAC input voltage
- ◆ Standard with 1-10V dimmable
- ◆ Power Factor : ≥0.95
- ◆ THD ≤20%
- ◆ 10KV Surge Protector go standard
- ◆ Light engines are available in 3000K, 4000K, 5000K or 5700K (70 CRI) configurations



Op cs :

- ◆ Type III, IV, V distributions optional

Finish :

- ◆ Dark bronze is standard. black, white and grey optional

Ambient Temperature:

- ◆ -40° F (-40° C) to 113° F (45° C)

Lis ng :

- ◆ UL Certified to meet U.S. and Canadian standards. Suitable for wet locations. Rated for -40°C minimum ambient. DesignLights Consortium® (DLC) Premium qualified product and DLC qualified product.

Warranty :

- ◆ 5-years limited warranty. Complete warranty terms located at:

Ordering Guide

EXAMPLE: XSYALH(240/260/280/310)WHV30KT3SFDP5

Brand X	Product name ALH	Wattage XXXW	Input Voltage AA	CCT XXK	Dist.Type Y	Mount Y	Finish Y	Photocontrol Y	Sensor Y
	ALH	80W 100W 150W 200W 240W 310W (80/100/120/150)W (170/200/220/240)W (240/260/280/310)W	Blank=120-277V HL=120-347V HV=277-480V	30K=3000K 40K=4000K 50K=5000K	T3=Type III T4=Type IV T5=Type V	SF=Slipfitter Mount PA=Square and Round Pole Mount Arm TR=Trunnion Mount AA=Adjustable Square and Round Pole Mount Arm	D=Dark Bronze B=Black W=White SG=Silver Grey	Blank=without Photocell P=with Photocell	S=with Motion Sensor Blank=without Motion Sensor

Specification

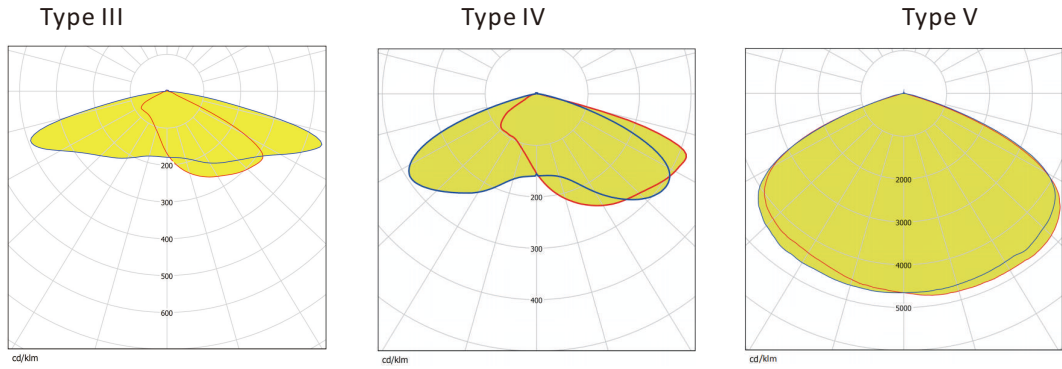

System Watts	Voltage	Distribution Type	4000K/5000K/5700K, 70CRI					3000K, 70CRI				
			Lumens	B	U	G	LPW	Lumens	B	U	G	LPW
80W	120-277V	T3	12,240	3	0	3	153	11,077	3	0	3	138
		T4	12,080	3	0	2	151	10,932	3	0	2	137
		T5	12,400	3	0	1	155	11,222	3	0	1	140
	120-347V	T3	12,400	3	0	3	155	11,222	3	0	3	140
		T4	12,240	3	0	2	153	11,077	3	0	2	138
		T5	12,560	3	0	1	157	11,367	3	0	1	142
	277-480V	T3	12,240	3	0	3	153	11,077	3	0	3	138
		T4	12,080	3	0	2	151	10,932	3	0	2	137
		T5	12,400	3	0	1	155	11,222	3	0	1	140
100W	120-277V	T3	15,300	3	0	3	153	13,847	3	0	3	138
		T4	15,100	3	0	2	151	13,666	3	0	2	137
		T5	15,500	3	0	1	155	14,028	3	0	1	140
	120-347V	T3	15,500	3	0	3	155	14,028	3	0	3	140
		T4	15,300	3	0	2	153	13,847	3	0	2	138
		T5	15,700	3	0	1	157	14,209	3	0	1	142
	277-480V	T3	15,300	3	0	3	153	13,847	3	0	3	138
		T4	15,100	3	0	2	151	13,666	3	0	2	137
		T5	15,500	3	0	1	155	14,028	3	0	1	140
150W	120-277V	T3	22,650	3	0	3	151	20,498	3	0	3	137
		T4	22,350	3	0	3	149	20,227	3	0	3	135
		T5	22,950	4	0	2	153	20,770	4	0	2	138
	120-347V	T3	22,950	3	0	3	153	20,770	3	0	3	138
		T4	22,650	3	0	3	151	20,498	3	0	3	137
		T5	23,250	4	0	2	155	21,041	4	0	2	140
	277-480V	T3	22,650	3	0	3	151	20,498	3	0	3	137
		T4	22,350	3	0	3	149	20,227	3	0	3	135
		T5	22,950	4	0	2	153	20,770	4	0	2	138
200W	120-277V	T3	30,400	4	0	4	152	27,512	4	0	4	138
		T4	30,000	4	0	3	150	27,150	4	0	3	136
		T5	30,800	5	0	2	154	27,874	5	0	2	139
	120-347V	T3	30,800	4	0	4	154	27,874	4	0	4	139
		T4	30,400	4	0	3	152	27,512	4	0	3	138
		T5	31,200	5	0	2	156	28,236	5	0	2	141
	277-480V	T3	30,400	4	0	4	152	27,512	4	0	4	138
		T4	30,000	4	0	3	150	27,150	4	0	3	136
		T5	30,800	5	0	2	154	27,874	5	0	2	139
240W	120-277V	T3	36,240	4	0	4	151	32,797	4	0	4	137
		T4	35,760	4	0	3	149	32,363	4	0	3	135
		T5	36,720	5	0	2	153	33,232	5	0	2	138
	120-347V	T3	36,720	4	0	4	153	33,232	4	0	4	138
		T4	36,240	4	0	3	151	32,797	4	0	3	137
		T5	37,200	5	0	2	155	33,666	5	0	2	140
	277-480V	T3	36,240	4	0	4	151	32,797	4	0	4	137
		T4	35,760	4	0	3	149	32,363	4	0	3	135
		T5	36,720	5	0	2	153	33,232	5	0	2	138
310W	120-277V	T3	46,810	4	0	4	151	42,363	4	0	4	137
		T4	46,190	4	0	3	149	41,802	4	0	3	135
		T5	47,430	5	0	2	153	42,924	5	0	2	138
	120-347V	T3	47,430	4	0	4	153	42,924	4	0	4	138
		T4	46,810	4	0	3	151	42,363	4	0	3	137
		T5	48,050	5	0	2	155	43,485	5	0	2	140
	277-480V	T3	46,810	4	0	4	151	42,363	4	0	4	137
		T4	46,190	4	0	3	149	41,802	4	0	3	135
		T5	47,430	5	0	2	153	42,924	5	0	2	138

Photometric Diagrams



Isofootcandle plots for the 150W-5000K. Distances are in units of mounting height(30')

LEGEND

-  0.1 fc
-  0.5 fc
-  1.0 fc

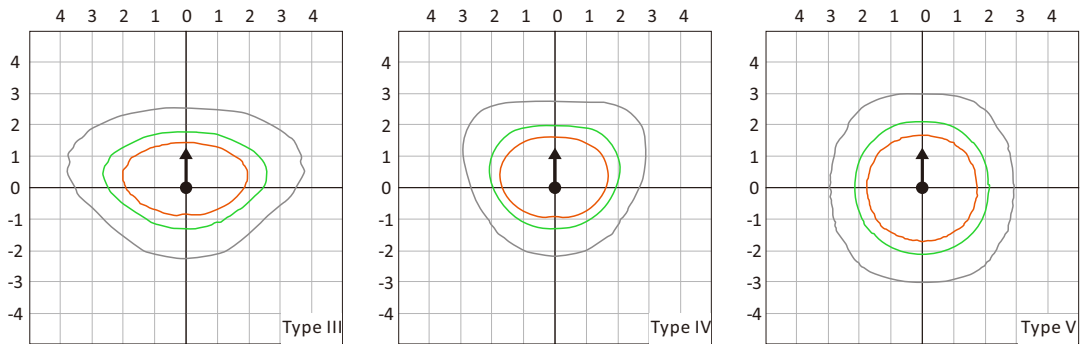

Accessories

Glare Shield



External Half Glare Shield

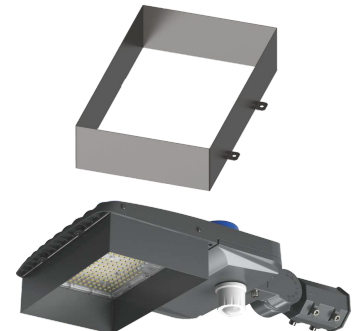

External 360 Full Visor

Control Options



Photocell

120-277V/120-347V/208-480V



Shorting Cap



PIR Motion Sensor

12V











Surge Protection Device

120-277V/347-480V

The SPD is included as standard for wattage from 150W and higher

EPA (Square and round pole arm)

*Includes luminaire and integral mounting arm. Other tenons, arms, brackets or other accessories are not included in this EPA data

Mounting Type	Tilt	EPA (ft ²)								
		Single	2@90	2@180	3@90	3@120	4@90	2 Side by Side	3 Side by Side	4 Side by Side
										
80W 100W 150W	0°	0.23	0.41	0.42	0.60	0.54	0.80	0.46	0.69	0.91
	10°	0.18	0.35	0.35	0.53	0.46	0.69	0.35	0.53	0.71
	20°	0.17	0.34	0.34	0.51	0.44	0.67	0.34	0.52	0.69
	30°	0.21	0.37	0.39	0.54	0.48	0.74	0.42	0.64	0.85
	40°	0.27	0.40	0.45	0.58	0.55	0.80	0.54	0.81	1.08
	45°	0.30	0.42	0.50	0.60	0.58	0.83	0.61	0.91	1.21
	50°	0.45	0.61	0.72	0.87	0.85	1.21	0.89	1.34	1.79
	60°	0.73	0.99	1.19	1.41	1.39	1.96	1.47	2.20	2.94
	70°	0.95	1.38	1.57	1.96	1.90	2.74	1.90	2.86	3.81
200W 240W	0°	0.25	0.44	0.46	0.65	0.58	0.87	0.50	0.75	0.99
	10°	0.19	0.38	0.38	0.57	0.50	0.75	0.38	0.58	0.77
	20°	0.19	0.37	0.37	0.55	0.48	0.73	0.37	0.56	0.75
	30°	0.23	0.40	0.43	0.59	0.53	0.80	0.46	0.69	0.92
	40°	0.29	0.44	0.49	0.63	0.60	0.87	0.59	0.88	1.17
	45°	0.33	0.45	0.54	0.66	0.63	0.90	0.66	0.99	1.32
	50°	0.49	0.66	0.79	0.95	0.93	1.31	0.97	1.46	1.94
	60°	0.80	1.08	1.29	1.54	1.51	2.13	1.60	2.39	3.20
	70°	1.04	1.50	1.70	2.13	2.07	2.97	2.07	3.11	4.14
310W	0°	0.35	0.62	0.64	0.91	0.82	1.21	0.69	1.04	1.39
	10°	0.27	0.54	0.53	0.80	0.69	1.06	0.54	0.81	1.08
	20°	0.26	0.52	0.52	0.77	0.67	1.02	0.52	0.79	1.05
	30°	0.32	0.56	0.60	0.83	0.74	1.12	0.64	0.97	1.29
	40°	0.41	0.61	0.68	0.88	0.84	1.21	0.82	1.23	1.64
	45°	0.46	0.63	0.76	0.92	0.89	1.26	0.92	1.38	1.85
	50°	0.68	0.93	1.10	1.32	1.30	1.84	1.36	2.04	2.72
	60°	1.12	1.51	1.81	2.15	2.12	2.99	2.24	3.35	4.47
	70°	1.45	2.09	2.38	2.99	2.90	4.16	2.90	4.35	5.79
80°	1.72	2.60	2.88	3.72	3.60	5.18	3.44	5.17	6.89	
90°	1.95	3.02	3.32	4.35	4.22	6.03	3.91	5.86	7.82	

Mounting Information

Universal bracket

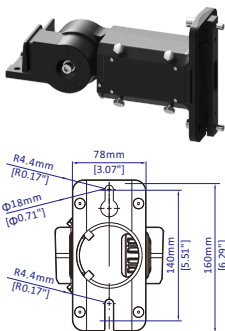

Square & Round Pole Mount

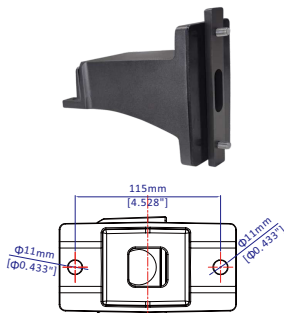

Adjustable Square & Round Pole Mount

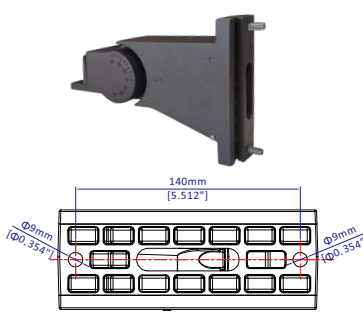

Slip Fitter Mount

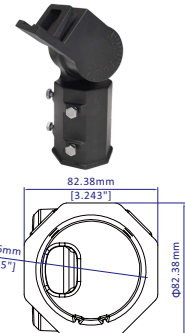

Trunnion Mount

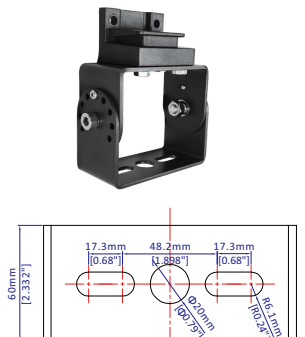

Dimensions & Weight

80W/ 100W/120W/ 150W

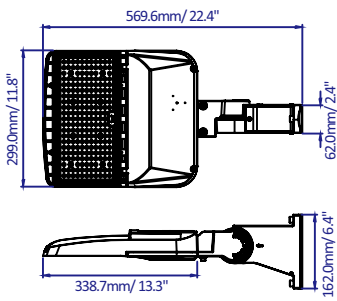

Net Weight: 4.4kgs/9.7Lbs

170W/ 200W /220W/ 240W

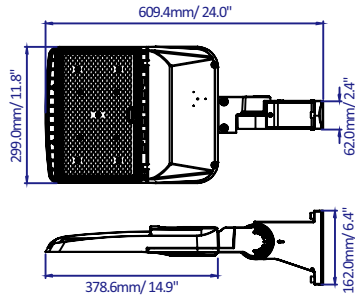

Net Weight: 4.7kgs/10.4Lbs

240W/ 260W /280W/ 310W

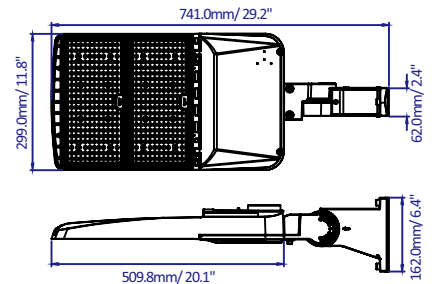

Net Weight: 6kgs/13.2Lbs

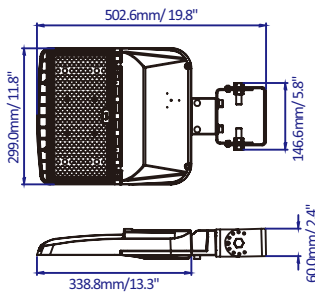

Net Weight: 4.4kgs/9.7Lbs

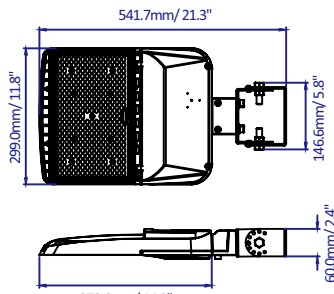

Net Weight: 4.7kgs/10.4Lbs

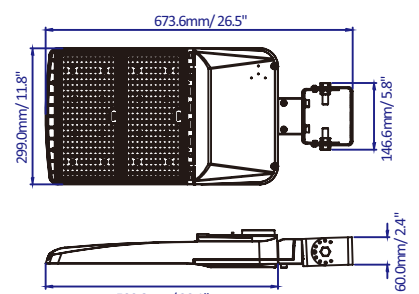

Net Weight: 6kgs/13.2Lbs

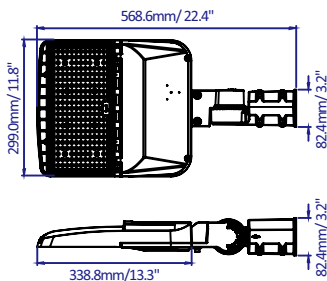

Net Weight: 4.6kgs/10.1Lbs

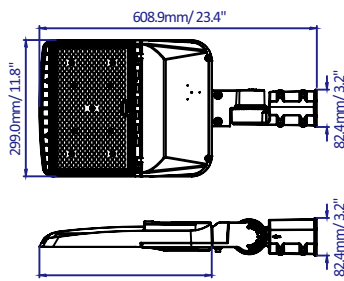

Net Weight: 4.9kgs/10.8Lbs

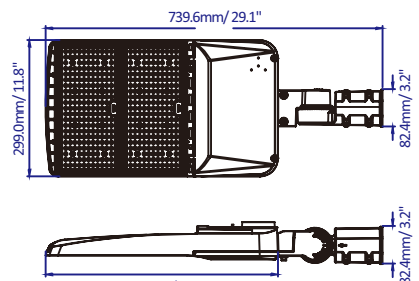

Net Weight: 6.2kgs/13.7Lbs

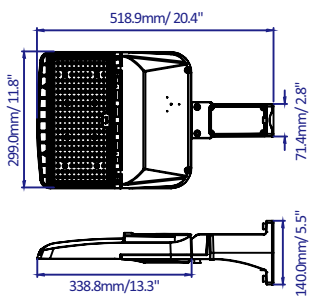

Net Weight: 5kgs/11.0Lbs

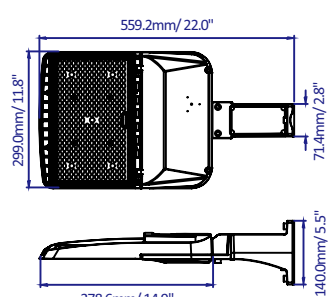

Net Weight: 5.3kgs/11.7Lbs

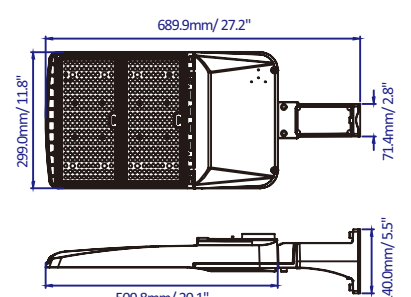

Net Weight: 6.6kgs/14.6Lbs