



150lm/w
LUMINOUS EFFICACY

VPD-4A & 4B
LED Vapor Tight Fixture
4FT 60W 40W



APPLICATION:

- Wet areas
- Outside walkways
- Warehouses
- Storage areas
- Industrial units
- Farm buildings (Non-corrosive atmosphere)
- Garages
- Workshops
- Car parks
- Changing rooms
- Resistant to impact and many chemical agents, but for suitability in specific environments please take specialist advice

CONSTRUCTION:

- Grey coloured polycarbonate
- Polycarbonate diffuser integrated with powder coated lighting tray
- Stainless steel clips
- Reinforced drill points in base for direct surface fixing, or conduit suspension.
- Stainless steel surface mounting clips
- Can also be suspended from wire/chain using clips provided



Supermarket



Farm buildings



Parking Garage

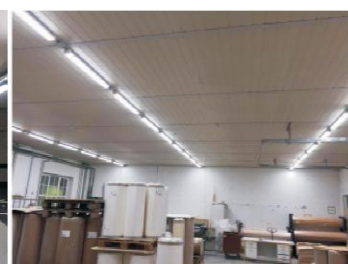

Warehouse

ADVANCED DESIGN

- Diffuse integrated with lighting tray
- Save installation steps and time
- Provide protection on LEDs

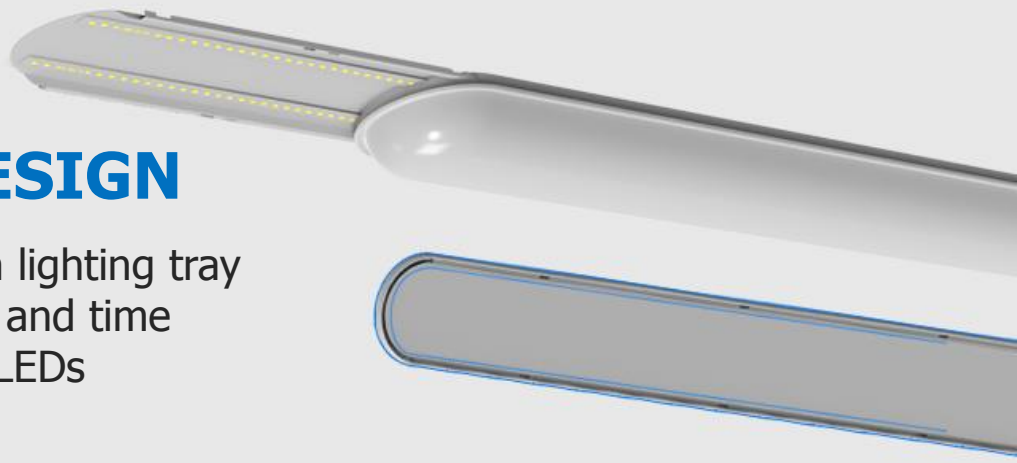

QUICK INSTALLATION

“ Diffuse integrated with lighting tray ”

Be mounted to the base directly

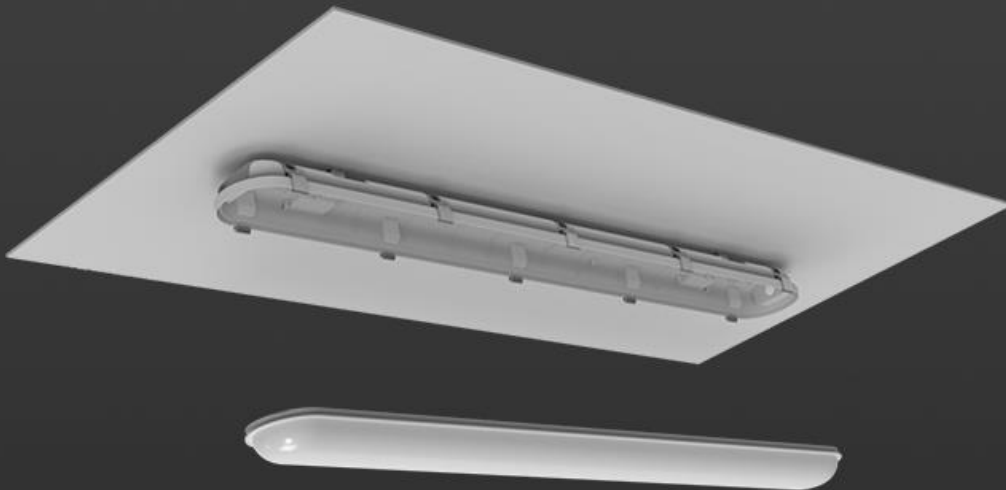

3 Step

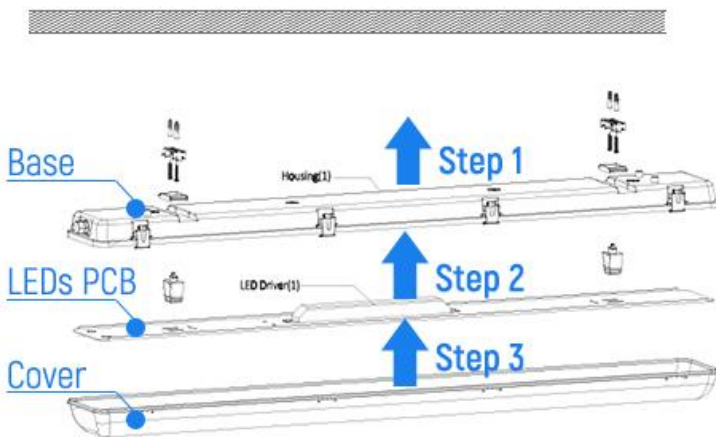

Other supplier LED Vapor Light

2 Step

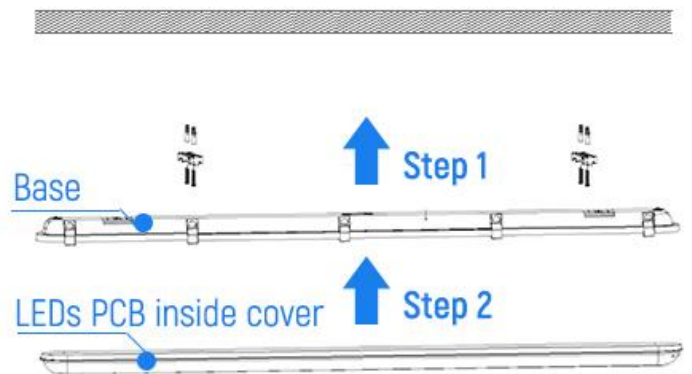

Save step , Save time, save money

CGT LED Vapor Tight

IP66

-40° C ~ 50° C
WORKING TEMPERATURE



MOUNTING TOLERANCE
+/-40MM



CONNECTION OF POWER
FROM SEVERAL SIDES



STAINLESS STEEL CLIPS
WITH HOLE DESIGN

Can be opened or locked Easily By hand



Parameter

Model No.	VPD-4AxxxxD	VPD-4BxxxxD	VPD-4BxxxxN
Wattage	60W	40W	40W
Luminous Efficacy	130lm/w (Frosted) 150lm/w (Clear)	130lm/w (Frosted) 150lm/w (Clear)	110lm/w (Frosted) 150lm/w (Clear)
Lumens output	7800lm (Frosted) 9000lm (Clear)	5200lm (Frosted) 6000lm (Clear)	4400lm (Frosted) 5200lm (Clear)
HID/MF Equivalent	300W	150-200W	150-200W
Fixture Weight	2.5Kg(5.5lb)	2.5Kg(5.5lb)	2.5Kg(5.5lb)
LEDs Type	SMD2835		
CCT	3000K, 4000K, 5000K		
CRI	80+		
Beam Angle	120°		
Input Voltage	100-277Vac or 100-347Vac		
Dimmable	0-10V dimming	0-10V dimming	Non-dimming
Power Factor	>0.90		
IP Rating	IP66 /Wet Location		
Working Temp.	-40°C ~ 50°C(-40°F ~ 122°F)		
Housing	PC		
Installation	Surface Mount /Chain /J-BOX Mounting		
Lifespan(L70)	>100,000 Hours		
Warranty	5 Years		
Certification	UL/cUL DLC Premium		

Dimension

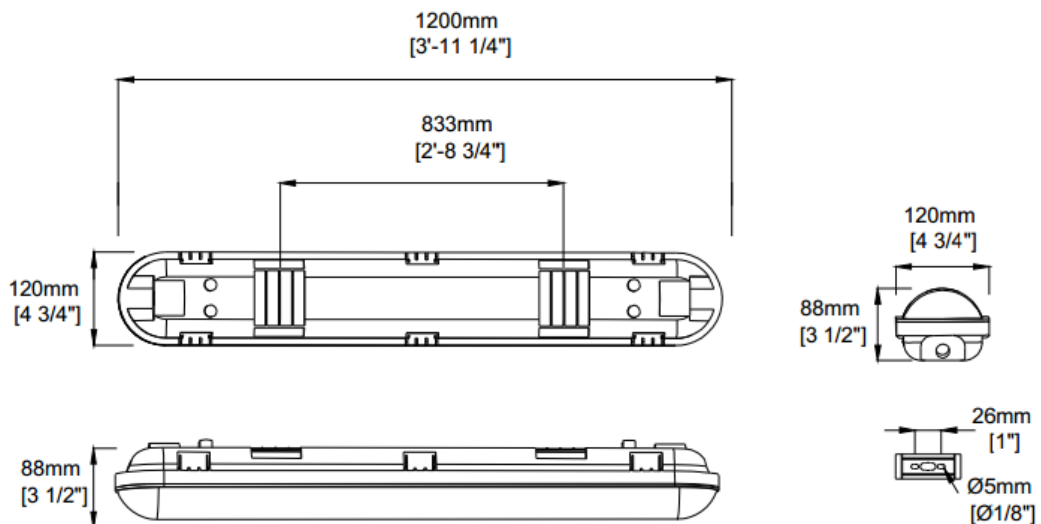

Order Information

Sample: VPD-4B50KFD

Product Family	CCT	Cover	Dimmable	Function
VPD-4A = 60W VPD-4B = 40W	30K = 3000K 40K = 5000K 50K = 5000K	F = Frosted C = Clear	D = Dimmable N = Non-Dimmable	Blank= No any Function SR= Lighting Control EM = Emergency RM = Lighting Control +Emergency
In Standard		Options (add as Suffix)		Accessories (order Separately)
130lm/w Frosted Cover Input Voltage: 100-277Vac 50/60Hz		347V = 100-347Vac Voltage Other customized		J-Box Installation Accessory Wire rope suspending kit Conduit Fitting #470 trde ½" size Conduit Fitting #470 trde ¾" size

Motion Sensor optional(BRI810-H-D)

Utilizing Field And Introduction

BRI810-H-D is a moving object sensor that can detect range of 360° and it's working frequency is 5.8GHz. The advantage of this product is stable working state (stable working temperature : -40°C~+70°C), BRI810-H-D adopts a microwave sensor (high-frequency output<0.2mW), so that it is safe and performs better than infrared sensor.



Function And Options



With sufficient natural light, the light does not switch on when presence detected.

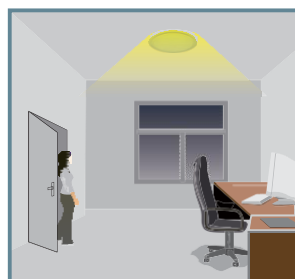

With insufficient natural light, the sensor switches on the light automatically when person come.

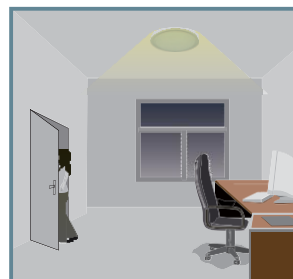

People left, light still dims to 0/10%/30%/50%(options) standby level after the hold time.

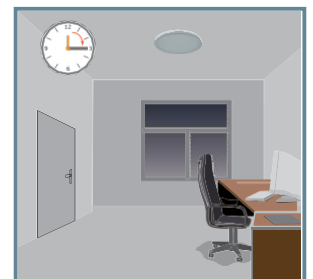

Light switches off automatically after after stand-by time elapsed.

Emergency

VPD-4A Emergency LED Drive

R/C, FTBR2/8, rated 100-277V, 50/60Hz, 65mA, 4W input. 15-55Vdc, 850 mA, 13.5W output. Charge Time, 24 Hours. Run Time, 90 minutes.

VPD-4B Emergency LED Driver

R/C, FTBR2/8, rated 100-277V, 50/60Hz, 50mA, 2.5W input. 15-55Vdc, 470 mA, 7W output. Charge Time, 24 Hours. Run Time, 90 minutes.



■ Photometric

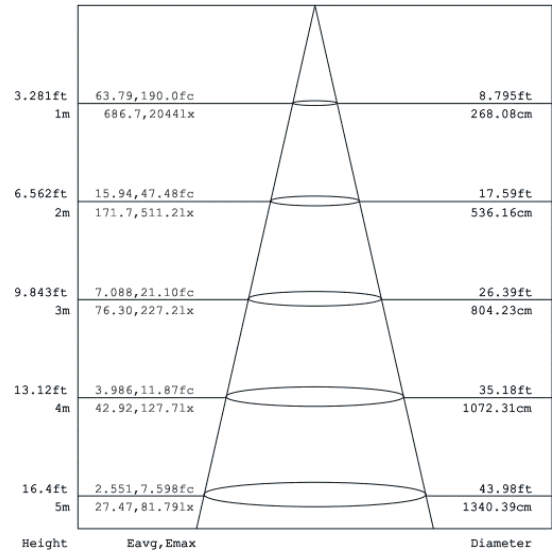
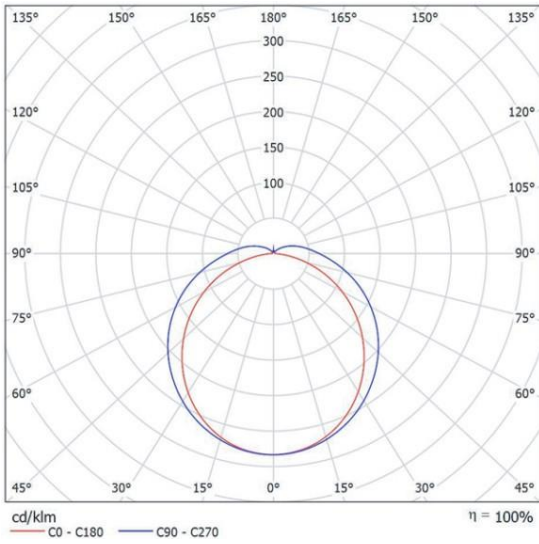

■ Package Information

ITEM	QTY/CTN	G. W.	CTN SIZE	Meas(CBM)
VPD-4A/4B	6pcs	16.5kg(36.3lb)	123x28x31cm (312.5"x71.1"x78.7")	0.11

■ Container Loading QTY

ITEM	20GP	40GP	40HQ
VPD-4A/4B	1590pcs	3288pcs	3852pcs